

# UHF narrow band radio data module **CDP-RX-03BS-R 434 MHz**



## Operation Guide

Version 1.0 (Apr. 2006)

---

### CIRCUIT DESIGN, INC.

7557-1 Hotaka, Azumino  
Nagano 399-8303 JAPAN  
Tel: + +81-(0)263-82-1024  
Fax: + +81-(0)263-82-1016

e-mail: [info@circuitdesign.jp](mailto:info@circuitdesign.jp)  
<http://www.cdt21.com>

## CONTENTS

GENERAL DESCRIPTION & FEATURES .....	3
OPERATING INSTRUCTIONS.....	4
Supply voltage .....	4
Data format.....	4
Outputs .....	4
Antennas .....	5
SPECIFICATIONS .....	6
PIN DESCRIPTION .....	7
BLOCK DIAGRAM .....	8
DIMENSIONS .....	9
RECOMMENDED PATTERN.....	10
TEST DATA .....	11
REGULATORY COMPLIANCE INFORMATION .....	12
Declaration of conformity .....	13
CAUTIONS & WARNINGS .....	14

## GENERAL DESCRIPTION & FEATURES

### Features

- 433-434MHz UHF band.
- RoHS Compliant
- R&TTE Compliant (EN 300 220)
- Very small compact integrated device with robust metal housing
- FM narrow band modulation and high frequency stability
- Low current consumption, ideal for mobile applications
- Control terminal for switching the power on/off

### Applications

- Remote control systems
- Telemetry systems
- Social alarm systems
- Security alarm systems
- Paging systems

### General description

The CDP-RX-03BS-R UHF FM-narrow band receiver is developed to cover a band plan of ERC Recommendation on Short Range Device (SRD) in the range of 433-434 MHz ISM band. The receiver design is based on the double Super-heterodyne principle enabling high signal sensitivity, high selectivity, and high frequency stability not achieved by simple SAW resonator receivers or other low cost designs.

Extensive filtering by an integrated unique SAW filter element enables operation in hazardous areas where interference may be expected. Steadily increasing use of the available frequency spectrum demands the application of narrow band systems for maximum operation reliability and fairness to other users of the ISM band.

The CDP-RX-03BS-R receiver module is designed to match the CDP-TX-04S-R transmitter modules, though signals from other FM-narrow transmitters can be received as well.

The receiver frequency must match with the transmitter frequency to enable reception. The CDP-RX-03BS-R is designed for PCB mounting. A simple wire can be soldered to the antenna input or the antenna can be printed on the PC board. An antenna with impedance matching with each frequency should be used.

The receiver module has AF, DATA and RSSI signal outputs, and one control pin.

## OPERATING INSTRUCTIONS

**Please read these instructions before you start using the CDP-RX-03BS-R.**

The CDP-RX-03BS-R is designed as a module for integration into a user system. It is not a ready-made product for private users. It can be regarded more like a special component of an electronic system. The user needs basic knowledge about electronics. Special knowledge about RF technology is helpful, but the most difficult parts are integrated into the modules to enable easy operation. Some additional information is given here:

### **Supply voltage:**

The CDP-RX-03BS-R receiver module contains a voltage regulator to guarantee stable performance in the given range of supply voltage.

The design was made for operation with a battery. Supply voltage must be used within specified voltage. The module shows unstable function with a voltage lower than specified. If a voltage connected to the Vcc (+) and Ground (-) terminal is beyond the maximum voltage given in the technical specification or is reversed, the module will be permanently damaged. To enable a low minimum voltage, no internal circuit is used to prevent damage by incorrect polarity.

If a higher supply voltage is available then a simple diode can be inserted in the connection line to the Vcc terminal to prevent damage by incorrect polarity. The diode must be rated for the maximum supply current detailed in the technical specifications.

### **Data format:**

Long intervals of HIGH or LOW bits should be avoided. Succeeding bits can be distorted in their pulse width. If the sequence of HIGH or LOW bits is too long then there is a possibility that the logic level of the data output will change. The maximum pulse width for continuous High and Low signal is 20 ms (96 bits) at 4800 bps. The minimum pulse width is 208 us. Maximum data rate is 4800 bps.

It is good to have a 20bit preamble (1010...) in front of the data to ensure communication reliability.

In general, at higher data rates (4800 Baud) the internal signal is shaped into a slope and jitter at the receiver data output increases.

Further advice can be given if the precise format of the data and system requirements are notified to the dealer or directly to Circuit Design, Inc. Your inquiries and comments are welcome.

### **Outputs:**

At the receiver side 3 output (AF, DATA and RSSI) signals and one control terminal are available.

AF output is the analog output from the FM detector circuit.

The DATA output is a digital output. This is the signal after AF signals pass through a band pass filter and comparator. For simple FSK modulation of digital data, the DATA out terminal can be used. The signal can be easily connected to other digital circuits.

The receiver has no internal mute circuit to avoid delays and achieve maximum sensitivity. The AF and DATA output will show noise on the output when no signal is received. Valid data signals can be detected by utilizing the RSSI output.

The third output is called RSSI. It is an indicator of the received signal strength. It can be used to drive an external mute circuit.

The control terminal can be used to control Vcc supply for the internal circuit.

### **Antennas:**

Most important for effective data transmission is selection of a good antenna, and RF grounding, both for the transmitter and the receiver. Without an antenna it is impossible to transmit data over a long distance.

The receiver has a simple antenna input pin. Any suitable UHF antenna can be connected to it. The easiest way to connect an antenna to the CDP-RX-03BS-R is to solder a 17.3 cm (433-434 MHz) wire directly to the antenna input. If the receiving antenna is installed away from the receiver module, a 50-Ohm coax antenna wire can be used. The shielding of the antenna wire should be soldered to the case near the antenna input of the CDP-RX-03BS-R.

It is possible, but not recommended to connect the receiver module and the antenna by a connection on a PCB. This will decrease the receiver performance in most cases.

In most cases the following basic rules will help you.

- Connect an antenna with 50-Ohm impedance.
- Lambda/4 whip antenna length is approximately 17.3 cm for 434 MHz.
- Place the antenna vertically, straight up or down from the transmitter and receiver module.
- Do not cover the antenna with metal parts.
- The connection of the metal surface of the transmitter case to a larger metal part (ground plane) will increase radiation efficiency. Such metal parts should not be placed near the antenna.
- The human body can have a similar effect to metal objects. Pocket transmitters should be held in the hand and held in a position away from the body and pointed in the direction of the receiver.
- Best range is achieved if the transmitter and receiver antenna are in direct line of sight. Any object in between the transmitter and receiver antenna, and metallic objects in particular, will decrease the range.
- The transmission is influenced by reflections of the transmitter signal on metallic surfaces and building. There is possibility that data errors will occur due to overlapping of the direct and reflected signals.

## SPECIFICATIONS

**RECEIVER: CDP-RX-03BS-R**

<i>RECEIVER TYPE</i>	Double Superheterodyne, Crystal oscillated single channel
<i>FREQUENCIES</i>	Fixed channel 433.920, 434.075 MHz *Other frequencies
<i>FREQUENCY STABILITY</i>	+/- 2.5 kHz (-10 to +60 C)
<i>PULSE WIDTH</i>	Min. 208 us Max. 20 ms
<i>DATA RATE</i>	100-4800 bps FSK
<i>OPERATING TEMP. RANGE</i>	-10 to +60 C
<i>SENSITIVITY</i>	-120 dBm (12 dB/SINAD, CCITT filter)
<i>SELECTIVITY</i>	+/-5 KHz at -6 dB point
<i>DEMODULATION</i>	FM narrow
<i>DISTORTION</i>	<5% at 1 KHz (AF output)
<i>S/N RATIO</i>	50 dB overall (AF output)
<i>DATA OUTPUT</i>	Digital output, pulled up to Vcc (22 kohm)
<i>OTHER OUTPUT</i>	RSSI, AF (-11 dBm typ. at Fm=1 kHz /Fmod=+/-3 kHz , 100 kohm)
<i>SUPPLY VOLTAGE</i>	3.0 to 14 V DC
<i>SUPPLY CURRENT</i>	16 mA (Typ.)
<i>I/O TERMINALS</i>	Ant, Gnd, Vcc, Data out, AF out, RSSI out, Power Control
<i>SIZE &amp; WEIGHT</i>	36 x 26 x 8 mm (7.5 cc), 12 g

\* Other frequencies: Please contact Circuit Design, Inc.

Note: Above specifications are subject to change for improvement without prior notice.

**PIN DESCRIPTION**

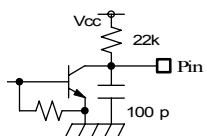
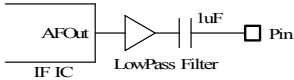
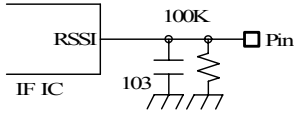
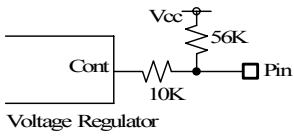
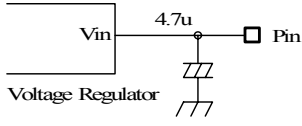
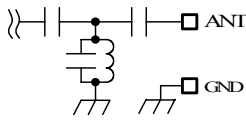
Pin-No.	Pin-Name	I/O	Description	Equivalent internal circuit
CN1-1	DATA	O	The data signal output The terminal is pulled up with a resistor	
CN1-2	AF	O	The AF signal output terminal The signal output level is -11dBm typ. (Fm=1 KHz /Fmod=+/-3 KHz, 100 Kohm)	
CN1-3	RSSI	O	The receiving level output The level indicates the strength of RF level	
CN1-4	CTRL	I	The power on/off control terminal. (Lo active) A voltage of Vcc-1.8 V or lower voltage makes the circuit active.	
CN1-5	VCC	-	The power supply terminal Operates on 3.0 to 14 V	
CN1-6	GND	-	The ground Connect to the ground of the control board.	
CN2-1	ANT	I	The antenna terminal Connect an antenna with 50 ohm impedance	
CN2-1	GND	-	The ground terminal for the antenna	

**BLOCK DIAGRAM**

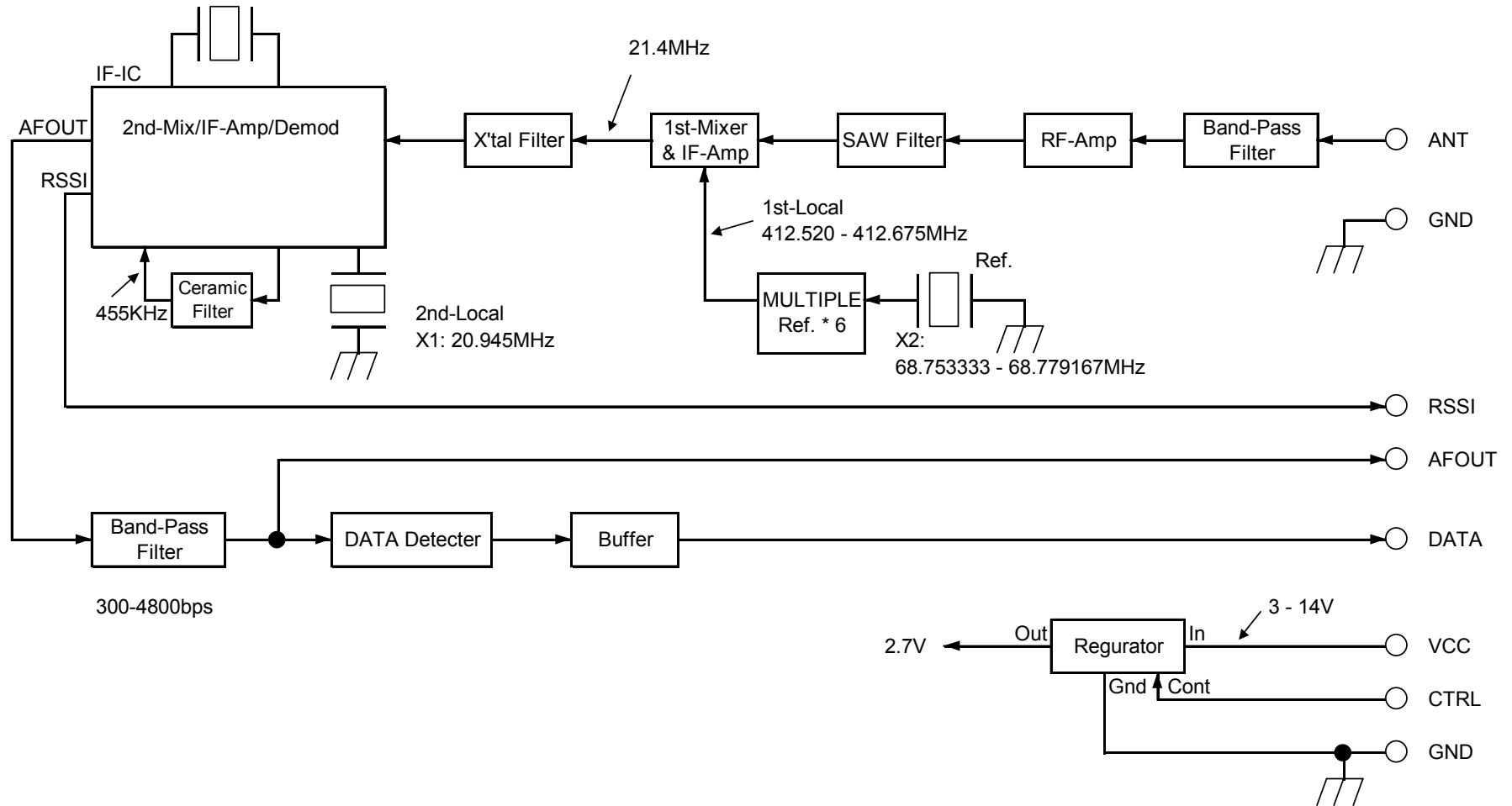



**DIMENSIONS**

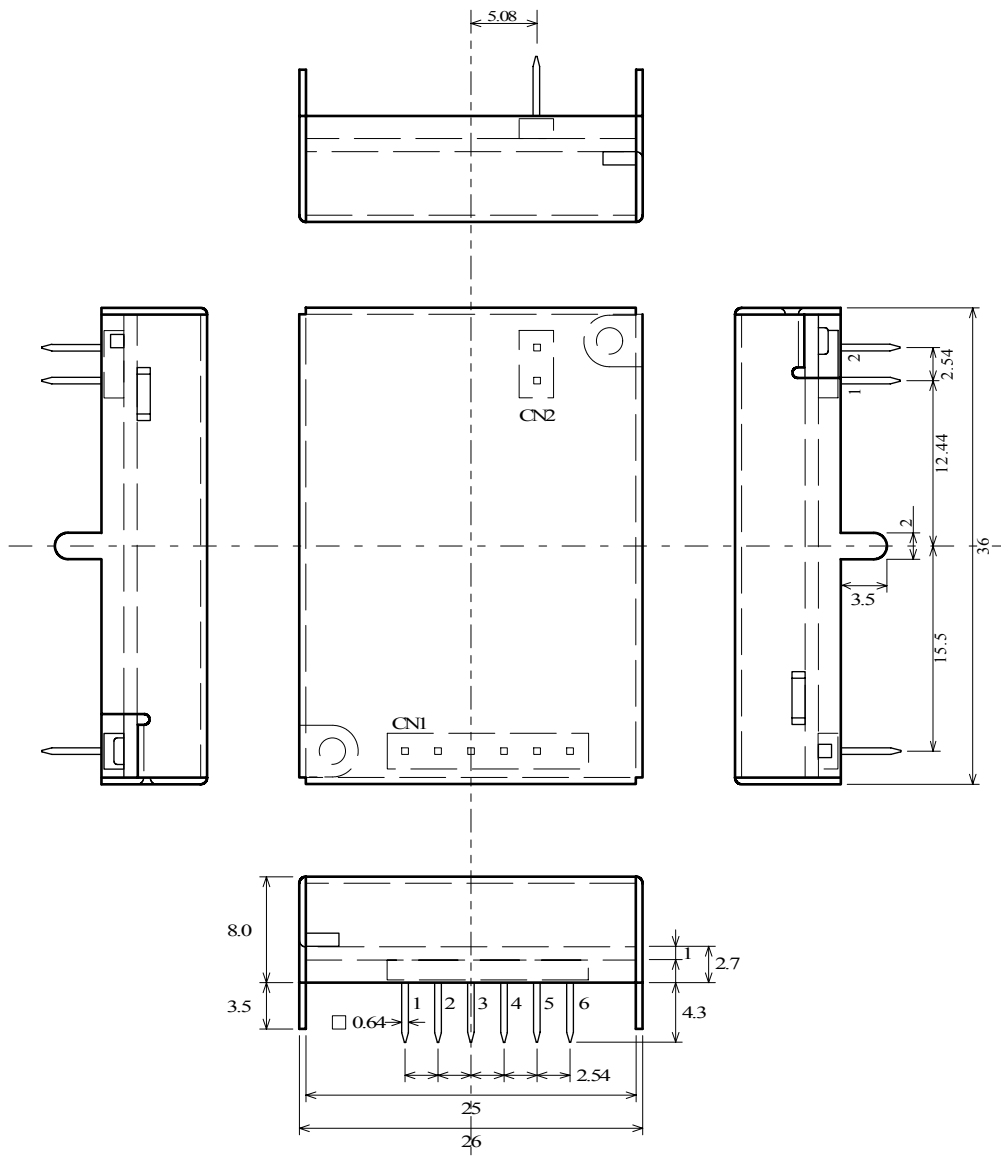

**PIN CONNECTION**

- CNI- 1: DATA
- 2: AF
- 3: RSSI
- 4: CTRL
- 5: Vcc
- 6: GND

- CN2- 1: ANT
- 2: GND

**RECOMMENDED PATTERN**

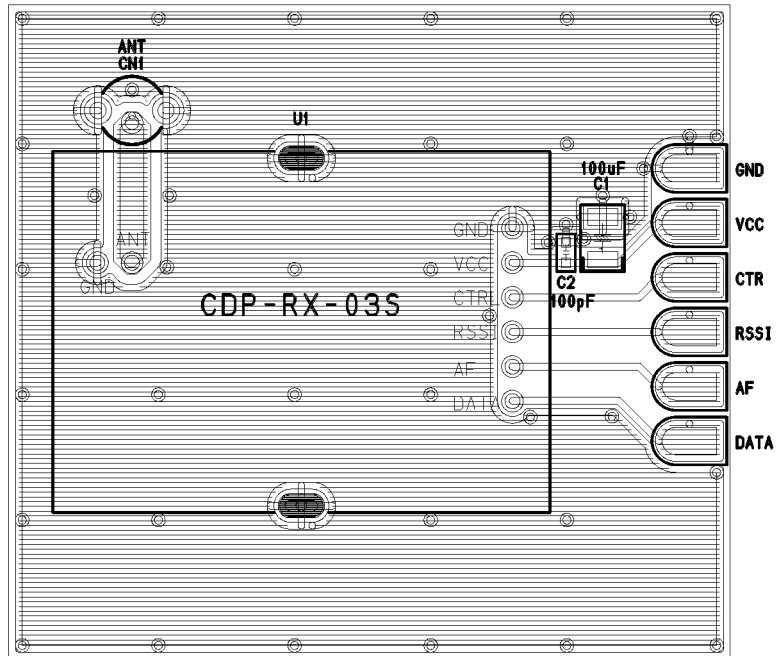

Component side

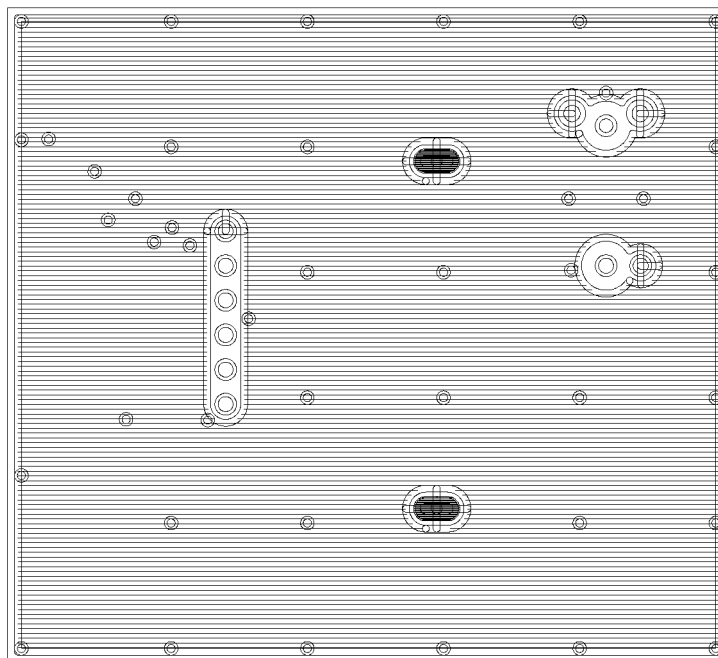

Back side

**TEST DATA**

RSSI (V)

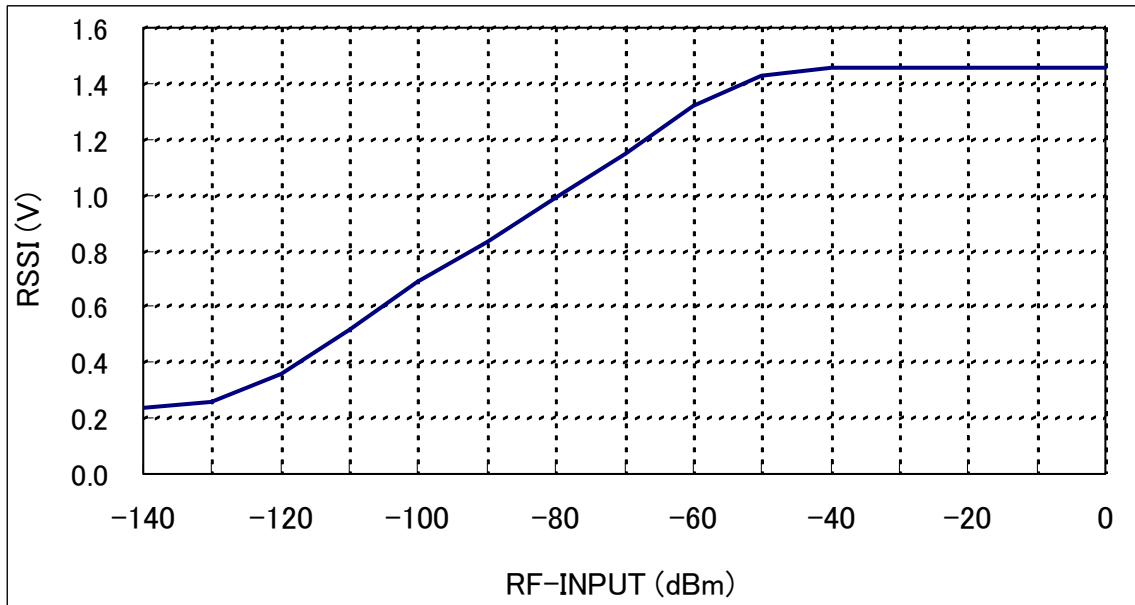

SIGNAL/NOISE RATIO (dB)

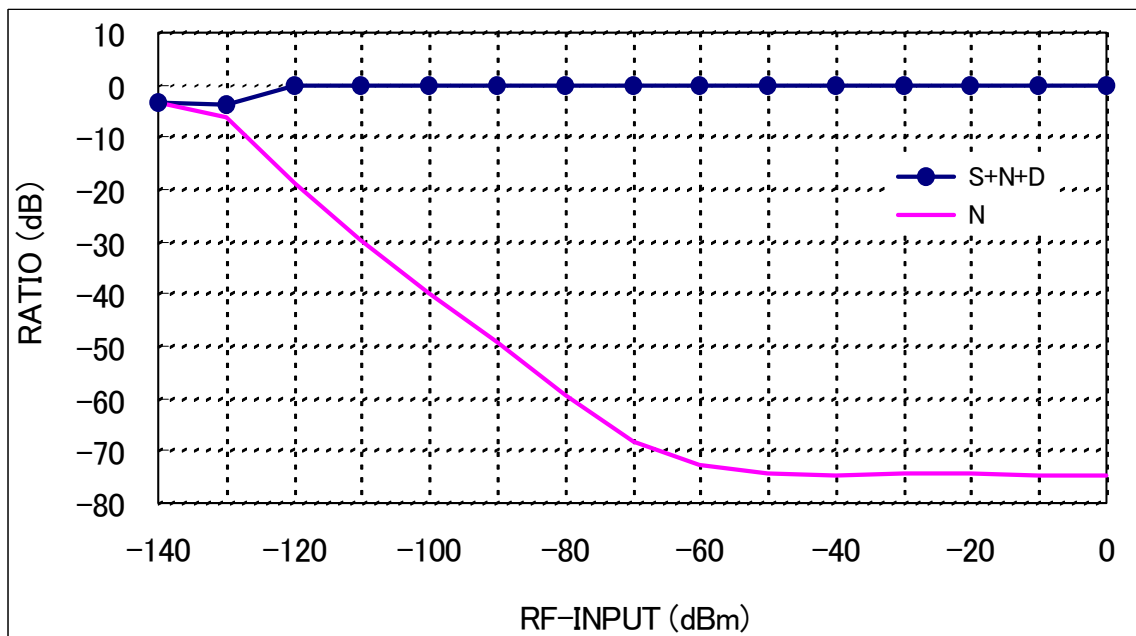

## Regulatory compliance information

### Regulatory compliance of the CDP-RX-03BS-R

The CDP-RX-03BS-R is designed for embedding in other equipment.

(Products incorporating the CDP-RX-03BS-R are henceforward referred to as final products.)

The European regulation applicable to the CDP-RX-03BS-R is the R&TTE Directive 1999/5/EC.

The conformity assessment for the CDP-RX-03BS-R was completed in accordance with the R&TTE Directive Annex II procedures, and the Declaration of Conformity is attached to this manual.

### Cautions related to regulatory compliance when embedding the CDP-RX-03BS-R

#### Enclosure

To fulfill the requirements of EMC and safety requirements, the CDP-RX-03BS-R should be mounted on the circuit board of the final product, and must be enclosed in the case of the final product. No surface of the CDP-RX-03BS-R should be exposed.

### Conformity assessment of the final product

The manufacturer of the final product is responsible for the conformity assessment procedures of the final product in accordance with the R&TTE Directive.

As to the conformity assessment of the R&TTE Directive Article 3.2 (Efficient use of the radio spectrum), the manufacturer of the final product incorporating the R&TTE assessed CDP-RX-03BS-R will be exempted from its conformity assessment procedures. For details of how to use the conformity assessment of the CDP-RX-03BS-R, please consult the relevant authorities or accredited certification bodies.

### Exemption clause

Circuit Design, Inc does not guarantee the accuracy of the above mentioned information about the conformity assessment and notification of the final product. Directives, technical standards, principles of operation and the like may be interpreted differently by the authorities in each country. Also the national laws and restrictions vary with the country. In case of doubt or uncertainty, we recommend that you check with the authorities or official certification organizations of the relevant countries.

## DECLARATION OF CONFORMITY

### Directive 99/5/EC (R&TTED)

Manufacturer or  
Authorized representative: Circuit Design, Inc.

Address: 7557-1, Hotaka, Azumino-city, Nagano  
399-8303 Japan

We declare on our sole responsibility, that the following product:

**Kind of equipment:** Receiver module

**Type-designation:** CDP-RX-03BS-R 433.050-434.790MHz

is in compliance with the essential requirements of §3 of the R&TTED.

- Health and safety requirements pursuant to §3(1)a:  
Applied Standard(s) or other means of providing conformity:  
EN 50371 : 2002  
EN 60950 : 2000
- Protection requirements concerning EMC §3(1)b:  
Applied Standard(s) or other means of providing conformity:  
EN 301-489-3 V1.4.1 (08.2002)
- Measures for the efficient use of the radio frequency spectrum §3(2)  
Applied Standard(s) or other means of providing conformity:  
EN 300 220-3 V1.1.1 (09.2000)

Hotaka, Japan April 6, 2006  
place and date of issue

  
Manufacturer/Authorized representative  
name and signature

**Accredited testlaboratory:** MIKES BABT SERVICE GmbH, Ohmstrasse 2-4  
94342 Strasskirchen, Germany

## Cautions

- As the radio module communicates using electronic radio waves, there are cases where transmission may be temporarily cut off due to factors in the environment of use or the method of usage. The manufacturer is exempt from all responsibility relating to harm to personnel or other equipment and other secondary damage.
- Do not use the equipment within the vicinity of devices that may malfunction as a result of electronic radio waves from the radio module.
- The manufacturer is exempt from all responsibility relating to secondary damage resulting from the operation, performance and reliability of equipment connected to the radio module.
- Communication performance will be affected by the environment of use, so communication tests should be carried out before actual use.
- Ensure that the power supply for the radio module is within the specified rating. Short circuits and reverse connections may result in overheating, and damage and must be avoided at all costs.
- Ensure that the power supply has been switched off before attempting any wiring work.
- The case is connected to the GND terminal of the internal circuit, so do not allow the '+' side of the power supply terminal to make contact with the case.
- When batteries are used as the power source, avoid short circuits, recharging, dismantling, and compression. Failure to observe this may result in the outbreak of fire, overheating and damage to the equipment. Remove the batteries when the equipment is not to be used for a long period of time. Failure to observe this may result in battery leaks and damage to the equipment.
- Do not use this equipment in vehicles with the windows closed, in locations where it is subject to direct sunlight, or in locations with extremely high humidity.
- The radio module is neither waterproof nor splash proof. Ensure that it is not splashed with dirt or water. Do not use the modules in equipment in which water or other foreign objects may enter the case.
- Do not drop the radio module or otherwise subject it to strong shocks.
- Do not subject the equipment to condensation (including moving it from cold locations to locations with a significant increase in temperature.)
- Do not use the equipment in locations where it is likely to be affected by acid, alkalis, organic agents or corrosive gas.
- Do not bend or break the antenna. Metallic objects placed in the vicinity of the antenna will have a significant effect on communication performance. As far as possible, ensure that the equipment is placed well away from metallic objects.
- The GND for the radio module will also affect communication performance. If possible, ensure that the case GND and the circuit GND are connected to a large GND pattern

## Warnings

- Do not take a part or modify the equipment.
- Do not remove the product label (the label attached to the upper surface of the module.) The use of modules from which the label has been removed is prohibited.

### **Circuit Design, Inc. All rights reserved**

No part of this document may be copied or distributed in part or in whole without the prior written consent of Circuit Design, Inc.

Customers are advised to consult with Circuit Design sales representatives before ordering.

Circuit Design, Inc. believes the furnished information is accurate and reliable. However, Circuit Design, Inc. reserves the right to make changes to this product without notice.

**Revision history**

Version	Date	Description	Remark
1.0	April. 2006	CDP-RX-03BS-R (RoHS compliant version) The first issue	