

# UHF Narrow band radio data module **CDP-TX/RX-02F-R 434 MHz**



## Operation Guide

Version 1.1 (Feb. 2007)

---

### **CIRCUIT DESIGN, INC.,**

7557-1 Hotaka, Azumino  
Nagano 399-8303 JAPAN  
Tel: + +81-(0)263-82-1024  
Fax: + +81-(0)263-82-1016

e-mail: [info@circuitdesign.jp](mailto:info@circuitdesign.jp)  
<http://www.cdt21.com>

## CONTENTS

GENERAL DESCRIPTION & FEATURES .....	3
SPECIFICATIONS .....	4
PIN DESCRIPTION.....	6
CHANNEL AND FREQUENCY SETTING.....	8
POWER SETTING .....	11
ANTENNAS.....	12
BLOCK DIAGRAM .....	13
DIMENSIONS .....	15
TEST DATA.....	17
REGULATORY COMPLIANCE INFORMATION .....	18
CAUTION & WARNINGS .....	20
REVISION HISTORY .....	21
APPLICATION NOTE .....	22

## GENERAL DESCRIPTION & FEATURES

### Features

- R&TTE (EN 300 220) / RoHS compliant
- 1 mW / 10 mW selectable
- Frequency selection free in 128 channels for 433 MHz
- High sensitivity receiver
- FM narrow band modulation

### Applications

- Radio remote control cranes and machines
- Factory automation M2M
- Security systems
- Alarms
- Telemetry systems

### Models

Model name	TX/RX	Ch setting
CDP-TX-02F-R 434MHz	Transmitter	Dip switches
CDP-RX-02F-R 434MHz	Receiver	Dip switches
CDP-TX-02FP-R 434MHz	Transmitter	Pin connectors
CDP-RX-02FP-R 434MHz	Receiver	Pin connectors

For the CDP-TX/RX-02F-R, frequency setting is performed with the 7-bit switches. Instead of these 7-bit switches, the CDP-TX/RX-02FP-R has 14-pin connectors for frequency setting, making it possible to set the channels externally.

There are no other technical and mechanical differences between CDP-02F-R and CDP-02FP-R.

### General description

The CDP-TX-02F-R and CDP-RX-02F-R are an RoHS compliant, embedded industrial narrowband FM radio transmitter and receiver.

They are suitable for various application fields such as wireless data communication, remote control, telemetry or wireless security systems. They are easy to use and integrate into application systems.

Both CDP-TX-02F-R and CDP-RX-02F-R are equipped with a frequency synthesizer system with micro controller. Available frequency ranges are from 433.1875 MHz to 434.7750 MHz (128 channels). The compact size, low operating voltage and frequency selectability of the CDP-02F-R make it ideal for various applications where its interference rejection and practical distance range is far better than similar RF modules based on wide band SAW-resonator frequency generators.

The CDP-RX-02F-R receiver has excellent blocking and adjacent channel selectivity.

**SPECIFICATIONS**

**CDP-TX-02F(P)-R Transmitter**

All ratings at 25°C +/- 5°C unless otherwise noted

Parameter	Rating	Conditions
<b>General characteristics</b>		
Applicable standard	EN 300 220 –3 Ver.1.1.1	
Communication method	One way	
Emission class	F1D	
Operating frequency range	433.1875 – 434.7750 MHz	
Operating temperature range	-20 to + 60°C	No dew condensation
Storage temperature range	-30 to + 70°C	No dew condensation
Aging rate	Max. +/- 1 ppm / year	TX freq. / RX Local freq.
Initial frequency tolerance	Max. +/- 2 ppm	At delivery *1
Dimension	26 x 36 x 10 mm	Excluding protrusion
Weight	14 g	Not including the antenna
<b>Electrical specification</b>		
Oscillation system	PLL controlled VCO	
Channel spacing	25 kHz	
Number of RF channels	128 ch (12.5 kHz step)	Default channel at delivery (434.775 MHz)
Data rate	300 to 4800 bps	(Pulse length Min. 208 us Max. 20 ms)
DI input level	L = Gnd H = 3V to Vcc	
Data polarity	Positive	TX DI vs RX DO
PLL reference frequency	21.25 kHz	TCXO
Antenna impedance	50 ohm	Nominal
Operating voltage	3 – 12 V	
Consumption current	Typ. 43 mA	At 10 mW / 3 V Max. 47 mA
	Typ. 33 mA	At 1 mW / 3V Max. 37 mA
<b>Transmitter part</b>		
RF output power	10 mW / 1mW	Selectable
Frequency stability	Max. +/- 4 ppm	- 20 to 60°C with reference frequency at 25°C
Deviation	+/- 2.1 kHz +/- 0.4 kHz	PN9, 4800 bps, LPF 20 kHz, (-20 to + 60°C)
Residual FM noise	0.17 kHz	DI = L, LPF 20 kHz
Modulation freq. characteristics	+/- 3 dB	50 to 2400 Hz
Spurious emission	- 54 dBm	47M-74M, 87.5M-118M, 174M-230M, 470M –862M
	- 36 dBm	Other frequencies below 1000 MHz
	- 30 dBm	Frequencies above 1000 MHz
Adjacent ch leakage power	-37 dBm	CH 25 kHz, BW 16 kHz, PN9, 4800 bps
Start up time	50 ms	From power on *2
	35 ms	Time required for channel change (50 kHz step) *3

Specifications are subject to change without prior notice

\*1 Initial frequency tolerance: At delivery

Initial frequency tolerance is defined as frequency drift within 1 year after the final adjustment

\*2 Start up time from power on

Time required for the TX frequency to reach within +/-1.5ppm of a stable frequency after power on

\*3 Start up time for channel change

Time required for the TX frequency to reach within +/-1.5ppm of a stable frequency after channel is selected

### CDP-RX-02F(P)-R Receiver

All ratings at 25°C +/- 5°C unless otherwise noted

Parameter	Rating	Conditions
<b>General characteristics</b>		
Applicable standard	EN 300 220 –3 Ver.1.1.1	
Communication method	One way	
Emission class	F1D	
Operating frequency range	433.1875 – 434.7750 MHz	
Operating temperature range	-20 to + 60 °C	No dew condensation
Storage temperature range	-30 to + 70 °C	No dew condensation
Aging rate	Max. +/- 1 ppm / year	TX freq. / RX Local Freq.
Initial freq. tolerance	Max. +/- 2 ppm	At delivery *1
Dimension	30 x 50 x 9 mm	Excluding protrusion
Weight	20 g	Not including the antenna
<b>Electrical specification</b>		
Oscillation system	PLL controlled VCO	
Channel spacing	25 kHz	
Number of RF channels	128 ch (12.5 kHz step)	Default channel at delivery (434.775 MHz)
Data rate	300 to 4800 bps	(Pulse length Min. 208 us Max. 20 ms)
DI input level	L = Gnd H = 3V to Vcc	
Data polarity	Positive	TX DI vs RX DO
PLL reference frequency	21.25 kHz	TCXO
Antenna impedance	50 ohm	Nominal
Operating voltage	3 – 12 V	
Consumption current	Typ. 30 mA at 3 V	
	Typ. 33 mA at 12 V	
<b>Receiver electrical specification</b>		
Receiver type	Double superheterodyne PLL synthesizer	
Bit error rate (0 error /2556 bits)	Typ. -116 dBm	At DO 4800 bps PN9 (-20°C to + 60°C)
Bit error rate (1% bit error)	Typ. -120 dBm	At DO 4800 bps PN9 (-20°C to + 60°C)
Sensitivity (12 dB / SINAD)	Typ. -120 dBm	fm1kHz, Dev.+/-2.0kHz, CCITT (-20 to + 60°C)
Frequency stability	Max. +/- 4 ppm	- 20 to 60°C with reference frequency at 25°C
Adjacent channel selectivity	60 dB	2 signal / 25 kHz / BER 1% / PN9 4800 bps
Blocking	84 dB	2 signal / All / BER 1% / PN9 4800 bps
	- 60 dBm	Below 1 GHz
Spurious radiation	- 50 dBm	Above 1 GHz
	- 30 dB	1 kHz Dev = +/-2.0 kHz CCITT (RF level -30 dBm)
S/N ratio	35 dB	1 kHz Dev = +/-2.0 kHz CCITT (RF level -30 dBm)
RSSI	235 mV +/- 40 mV	At -110 dBm
	195 mV +/- 40 mV	At -116 dBm
AF output level	145 mV +/- 30 mV	fmod = +/-2.0 kHz fm = 1.2 kHz (RF level -30 dBm)
	110 mV +/- 30 mV	fmod = +/-2.0 kHz fm = 2.4 kHz (RF level -30 dBm)
RSSI rising time	Typ. 20 ms / Max. 50 ms	Channel change (50 kHz) (-20°C to + 60°C)
	Typ. 40 ms / Max. 70 ms	At power on (-20°C to + 60°C)
Time to valid Data out *2	Typ. 50 ms / Max. 100 ms	Channel change (50 kHz) (-20°C to + 60°C)
	Typ. 70 ms / Max. 140 ms	At power on (-20°C to + 60°C)

Specifications are subject to change without prior notice

\*1 Initial frequency tolerance: At delivery

Initial frequency tolerance is defined as frequency drift within 1 year after the final adjustment

\*2 Time to valid output signal:

Valid output signal is determined at the point where the Bit Error Rate meter starts detecting a 4800bps, 1010.. repeated signal.

The valid output signal varies with the temperature conditions. You must conduct field testing to verify the waiting time for a valid output signal in the user system.

**PIN DESCRIPTION**

**CDP-TX-02F(P)-R**

Pin name	I/O	Description	Equivalent circuit
ANT	O	RF output terminal Antenna impedance nominal 50 Ω	
GND	I	The ground for the power supply. Connect it to the ground plane as well as to the bottom part of the case. The ground plane has an impact on the range and the stability of operation.	
VCC	I	The power supply terminal. The supply voltage is DC 3.0 to 12 V. Power supply noise and ripple have an impact on performance, so eliminate them as far as possible with filters and capacitors.	
DATAIN	I	Digital data input terminal Interface voltage: H = Vcc L = GND	

**CDP-RX-02F(P)-R**

Pin name	I/O	Description	Equivalent circuit
ANT	O	RF input terminal Antenna impedance nominal 50 Ω	
GND	I	The ground for the power supply. Connect it to the ground plane as well as to the bottom part of the case. The ground plane has an impact on the range and the stability of operation.	
VCC	I	The power supply terminal. The supply voltage is DC 3.0 to 12 V. Power supply noise and ripple have an impact on performance, so eliminate them as far as possible with filters and capacitors.	
RSSI	O	The receive level output of the receiver. The strength of the RF level (electric field intensity) is output as a direct-current voltage.	
DATA	I	Digital data output terminal Interface voltage: H = Vcc L = GND	
AF	O	The demodulated output of the receiver. The DC offset is about 1 V. Refer to the specifications for the amplitude level.	

**CHANNEL AND FREQUENCY SETTINGS**

By use of a chip mounted 7-bit switch or pins and a jumper on the PCB, you can select easily between the 128 channels. Before shipment all the modules are set to 434.775 MHz

Ch	Freq. (MHz)	7-bit Switch or PIN status *						
		1	2	3	4	5	6	7
0	433.1875	ON	ON	ON	ON	ON	ON	ON
1	433.2000	OFF	ON	ON	ON	ON	ON	ON
2	433.2125	ON	OFF	ON	ON	ON	ON	ON
3	433.2250	OFF	OFF	ON	ON	ON	ON	ON
4	433.2375	ON	ON	OFF	ON	ON	ON	ON
5	433.2500	OFF	ON	OFF	ON	ON	ON	ON
6	433.2625	ON	OFF	OFF	ON	ON	ON	ON
7	433.2750	OFF	OFF	OFF	ON	ON	ON	ON
8	433.2875	ON	ON	ON	OFF	ON	ON	ON
9	433.3000	OFF	ON	ON	OFF	ON	ON	ON
10	433.3125	ON	OFF	ON	OFF	ON	ON	ON
11	433.3250	OFF	OFF	ON	OFF	ON	ON	ON
12	433.3375	ON	ON	OFF	OFF	ON	ON	ON
13	433.3500	OFF	ON	OFF	OFF	ON	ON	ON
14	433.3625	ON	OFF	OFF	OFF	ON	ON	ON
15	433.3750	OFF	OFF	OFF	OFF	ON	ON	ON
16	433.3875	ON	ON	ON	ON	OFF	ON	ON
17	433.4000	OFF	ON	ON	ON	OFF	ON	ON
18	433.4125	ON	OFF	ON	ON	OFF	ON	ON
19	433.4250	OFF	OFF	ON	ON	OFF	ON	ON
20	433.4375	ON	ON	OFF	ON	OFF	ON	ON
21	433.4500	OFF	ON	OFF	ON	OFF	ON	ON
22	433.4625	ON	OFF	OFF	ON	OFF	ON	ON
23	433.4750	OFF	OFF	OFF	ON	OFF	ON	ON
24	433.4875	ON	ON	ON	OFF	OFF	ON	ON
25	433.5000	OFF	ON	ON	OFF	OFF	ON	ON
26	433.5125	ON	OFF	ON	OFF	OFF	ON	ON
27	433.5250	OFF	OFF	ON	OFF	OFF	ON	ON
28	433.5375	ON	ON	OFF	OFF	OFF	ON	ON
29	433.5500	OFF	ON	OFF	OFF	OFF	ON	ON
30	433.5625	ON	OFF	OFF	OFF	OFF	ON	ON
31	433.5750	OFF	OFF	OFF	OFF	OFF	ON	ON
32	433.5875	ON	ON	ON	ON	ON	OFF	ON
33	433.6000	OFF	ON	ON	ON	ON	OFF	ON
34	433.6125	ON	OFF	ON	ON	ON	OFF	ON
35	433.6250	OFF	OFF	ON	ON	ON	OFF	ON
36	433.6375	ON	ON	OFF	ON	ON	OFF	ON
37	433.6500	OFF	ON	OFF	ON	ON	OFF	ON
38	433.6625	ON	OFF	OFF	ON	ON	OFF	ON
39	433.6750	OFF	OFF	OFF	ON	ON	OFF	ON
40	433.6875	ON	ON	ON	OFF	ON	OFF	ON
41	433.7000	OFF	ON	ON	OFF	ON	OFF	ON
42	433.7125	ON	OFF	ON	OFF	ON	OFF	ON



Ch	Freq. (MHz)	7-bit Switch or PIN status *						
		1	2	3	4	5	6	7
43	433.7250	OFF	OFF	ON	OFF	ON	OFF	ON
44	433.7375	ON	ON	OFF	OFF	ON	OFF	ON
45	433.7500	OFF	ON	OFF	OFF	ON	OFF	ON
46	433.7625	ON	OFF	OFF	OFF	ON	OFF	ON
47	433.7750	OFF	OFF	OFF	OFF	ON	OFF	ON
48	433.7875	ON	ON	ON	ON	OFF	OFF	ON
49	433.8000	OFF	ON	ON	ON	OFF	OFF	ON
50	433.8125	ON	OFF	ON	ON	OFF	OFF	ON
51	433.8250	OFF	OFF	ON	ON	OFF	OFF	ON
52	433.8375	ON	ON	OFF	ON	OFF	OFF	ON
53	433.8500	OFF	ON	OFF	ON	OFF	OFF	ON
54	433.8625	ON	OFF	OFF	ON	OFF	OFF	ON
55	433.8750	OFF	OFF	OFF	ON	OFF	OFF	ON
56	433.8875	ON	ON	ON	OFF	OFF	OFF	ON
57	433.9000	OFF	ON	ON	OFF	OFF	OFF	ON
58	433.9125	ON	OFF	ON	OFF	OFF	OFF	ON
59	433.9250	OFF	OFF	ON	OFF	OFF	OFF	ON
60	433.9375	ON	ON	OFF	OFF	OFF	OFF	ON
61	433.9500	OFF	ON	OFF	OFF	OFF	OFF	ON
62	433.9625	ON	OFF	OFF	OFF	OFF	OFF	ON
63	433.9750	OFF	OFF	OFF	OFF	OFF	OFF	ON
64	433.9875	ON	ON	ON	ON	ON	ON	OFF
65	434.0000	OFF	ON	ON	ON	ON	ON	OFF
66	434.0125	ON	OFF	ON	ON	ON	ON	OFF
67	434.0250	OFF	OFF	ON	ON	ON	ON	OFF
68	434.0375	ON	ON	OFF	ON	ON	ON	OFF
69	434.0500	OFF	ON	OFF	ON	ON	ON	OFF
70	434.0625	ON	OFF	OFF	ON	ON	ON	OFF
71	434.0750	OFF	OFF	OFF	ON	ON	ON	OFF
72	434.0875	ON	ON	ON	OFF	ON	ON	OFF
73	434.1000	OFF	ON	ON	OFF	ON	ON	OFF
74	434.1125	ON	OFF	ON	OFF	ON	ON	OFF
75	434.1250	OFF	OFF	ON	OFF	ON	ON	OFF
76	434.1375	ON	ON	OFF	OFF	ON	ON	OFF
77	434.1500	OFF	ON	OFF	OFF	ON	ON	OFF
78	434.1625	ON	OFF	OFF	OFF	ON	ON	OFF
79	434.1750	OFF	OFF	OFF	OFF	ON	ON	OFF
80	434.1875	ON	ON	ON	ON	OFF	ON	OFF
81	434.2000	OFF	ON	ON	ON	OFF	ON	OFF
82	434.2125	ON	OFF	ON	ON	OFF	ON	OFF
83	434.2250	OFF	OFF	ON	ON	OFF	ON	OFF
84	434.2375	ON	ON	OFF	ON	OFF	ON	OFF
85	434.2500	OFF	ON	OFF	ON	OFF	ON	OFF
86	434.2625	ON	OFF	OFF	ON	OFF	ON	OFF
87	434.2750	OFF	OFF	OFF	ON	OFF	ON	OFF
88	434.2875	ON	ON	ON	OFF	OFF	ON	OFF
89	434.3000	OFF	ON	ON	OFF	OFF	ON	OFF

Ch	Freq. (MHz)	7-bit Switch or PIN status *						
		1	2	3	4	5	6	7
90	434.3125	ON	OFF	ON	OFF	OFF	ON	OFF
91	434.3250	OFF	OFF	ON	OFF	OFF	ON	OFF
92	434.3375	ON	ON	OFF	OFF	OFF	ON	OFF
93	434.3500	OFF	ON	OFF	OFF	OFF	ON	OFF
94	434.3625	ON	OFF	OFF	OFF	OFF	ON	OFF
95	434.3750	OFF	OFF	OFF	OFF	OFF	ON	OFF
96	434.3875	ON	ON	ON	ON	ON	OFF	OFF
97	434.4000	OFF	ON	ON	ON	ON	OFF	OFF
98	434.4125	ON	OFF	ON	ON	ON	OFF	OFF
99	434.4250	OFF	OFF	ON	ON	ON	OFF	OFF
100	434.4375	ON	ON	OFF	ON	ON	OFF	OFF
101	434.4500	OFF	ON	OFF	ON	ON	OFF	OFF
102	434.4625	ON	OFF	OFF	ON	ON	OFF	OFF
103	434.4750	OFF	OFF	OFF	ON	ON	OFF	OFF
104	434.4875	ON	ON	ON	OFF	ON	OFF	OFF
105	434.5000	OFF	ON	ON	OFF	ON	OFF	OFF
106	434.5125	ON	OFF	ON	OFF	ON	OFF	OFF
107	434.5250	OFF	OFF	ON	OFF	ON	OFF	OFF
108	434.5375	ON	ON	OFF	OFF	ON	OFF	OFF
109	434.5500	OFF	ON	OFF	OFF	ON	OFF	OFF
110	434.5625	ON	OFF	OFF	OFF	ON	OFF	OFF
111	434.5750	OFF	OFF	OFF	OFF	ON	OFF	OFF
112	434.5875	ON	ON	ON	ON	OFF	OFF	OFF
113	434.6000	OFF	ON	ON	ON	OFF	OFF	OFF
114	434.6125	ON	OFF	ON	ON	OFF	OFF	OFF
115	434.6250	OFF	OFF	ON	ON	OFF	OFF	OFF
116	434.6375	ON	ON	OFF	ON	OFF	OFF	OFF
117	434.6500	OFF	ON	OFF	ON	OFF	OFF	OFF
118	434.6625	ON	OFF	OFF	ON	OFF	OFF	OFF
119	434.6750	OFF	OFF	OFF	ON	OFF	OFF	OFF
120	434.6875	ON	ON	ON	OFF	OFF	OFF	OFF
121	434.7000	OFF	ON	ON	OFF	OFF	OFF	OFF
122	434.7125	ON	OFF	ON	OFF	OFF	OFF	OFF
123	434.7250	OFF	OFF	ON	OFF	OFF	OFF	OFF
124	434.7375	ON	ON	OFF	OFF	OFF	OFF	OFF
125	434.7500	OFF	ON	OFF	OFF	OFF	OFF	OFF
126	434.7625	ON	OFF	OFF	OFF	OFF	OFF	OFF
127	434.7750	OFF	OFF	OFF	OFF	OFF	OFF	OFF

\* Channel No. 127 : Default setting

**Channel Table**

7 bit switch: ON = L (GND) OFF = H (Open)  
 PIN status: ON = L (Short to GND pin) OFF = H (Open)

Position of the SW and Pins.

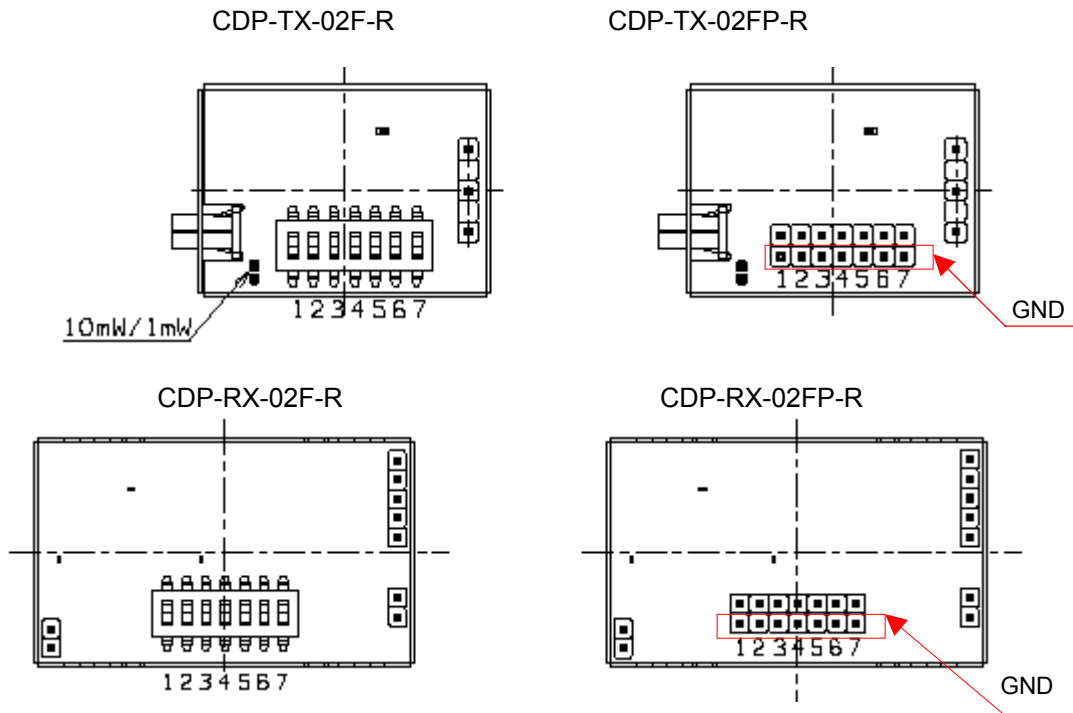

## POWER SETTING

CDP-TX-02F(P)-R can be set to either 10 mW or 1 mW by a jumper on the PCB.

**Power Setting** (Switch: ON = “L” / OFF = “H”)

10 mW: Jumper ON (Default)    1 mW: Jumper OFF

**Note:**

The power level limit of the 434 MHz ISM band in Europe is defined as below. Please choose the maximum power and duty cycle allowed by the regulations.

Frequency band	Power	Duty cycle	Channel spacing
433.050 MHz – 434.790 MHz	10 mW e.r.p.	<10%	No spacing
433.050 MHz – 434.790 MHz	1 mW e.r.p. - 13 dBm/10kHz	Up to 100%	No spacing
434.040 MHz – 434.790 MHz	10 mW e.r.p.	Up to 100%	Up to 25 kHz

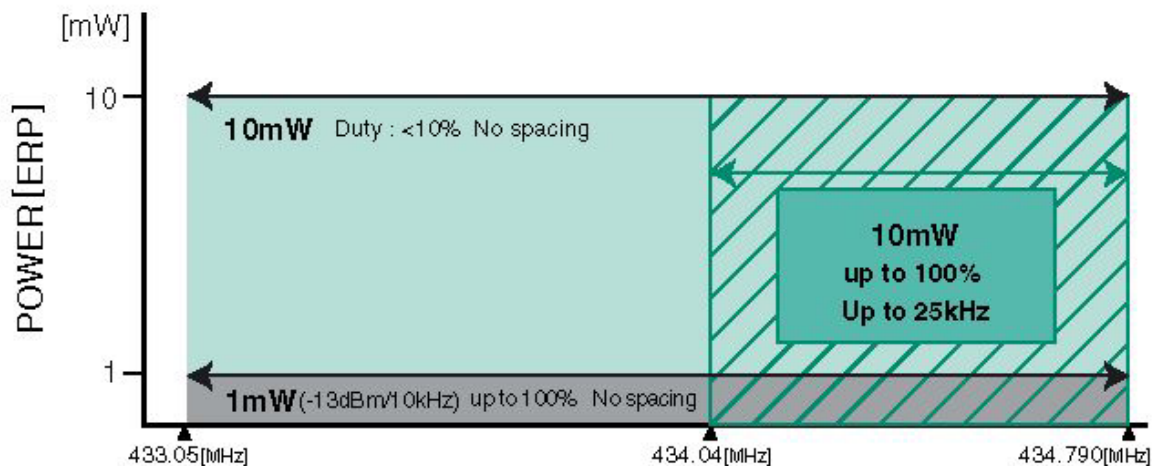

## ANTENNAS

The most important factors for safe data transmission are a good antenna and RF grounding, both for the transmitter and the receiver. Without an antenna it is impossible to transmit data over a long distance.

The standard antenna is a Lambda/4 wire protected by a plastic cover.

The receiver has a simple antenna input pin. Any suitable UHF antenna can be connected to it.

The easiest way to connect an antenna to the CDP-RX-02F-R is to solder a 17 cm wire directly to the antenna input. A 50 Ohm coaxial cable can be used to extend the distance between the antenna and the receiver. The shielding of the antenna wire should be soldered to the case near the antenna input of the CDP-RX-02F-R.

It is possible, but not recommended to connect the receiver module and the antenna by a connection on the PCB. This will decrease the receiver performance in most cases.

To find the best method of installation for the transmitter and receiver, many things should be considered and tested. It is recommended that you read specialized literature on antennas and radiation characteristics to gain a better understanding of these fields. A detailed explanation cannot be given here.

**Notice: For CDP-TX-02F-R and CDP-TX-02FP-R, use the antenna provided. Using other antennas may invalidate compliance with the regulatory standards. Refer to the REGULATORY COMPLIANCE INFORMATION in this document.**

In most cases the following basic rules will help you.

- Connect an antenna with 50 Ohm impedance for 434 MHz.
- The easiest construction is a wire of approximately 17 cm.
- Place the antenna vertically, straight up or down from the transmitter and receiver module.
- Do not cover the antenna with metal parts.
- The connection of the metal surface of the transmitter and receiver case to a larger metal part (ground plane) will increase radiation and reception efficiency. These metal parts should not be placed near the antenna.
- The best range is achieved if the transmitter and receiver antenna are in direct line of sight. Any object in between the transmitter and receiver antenna, and metallic objects in particular, will decrease the range.
- The transmission is influenced by reflections of the transmitter signal on metallic surfaces. By overlaying the direct and reflected signal with a 180 degree phase shift the signal can almost fade out. These reflections and fade-outs can result in data drop-outs in mobile applications.
- The human body can have a similar effect as metal objects. Pocket transmitters should be held in your hand, held in a position away from the body and pointed in the direction of the receiver.

**BLOCK DIAGRAM <CDP-TX-02F-R>**

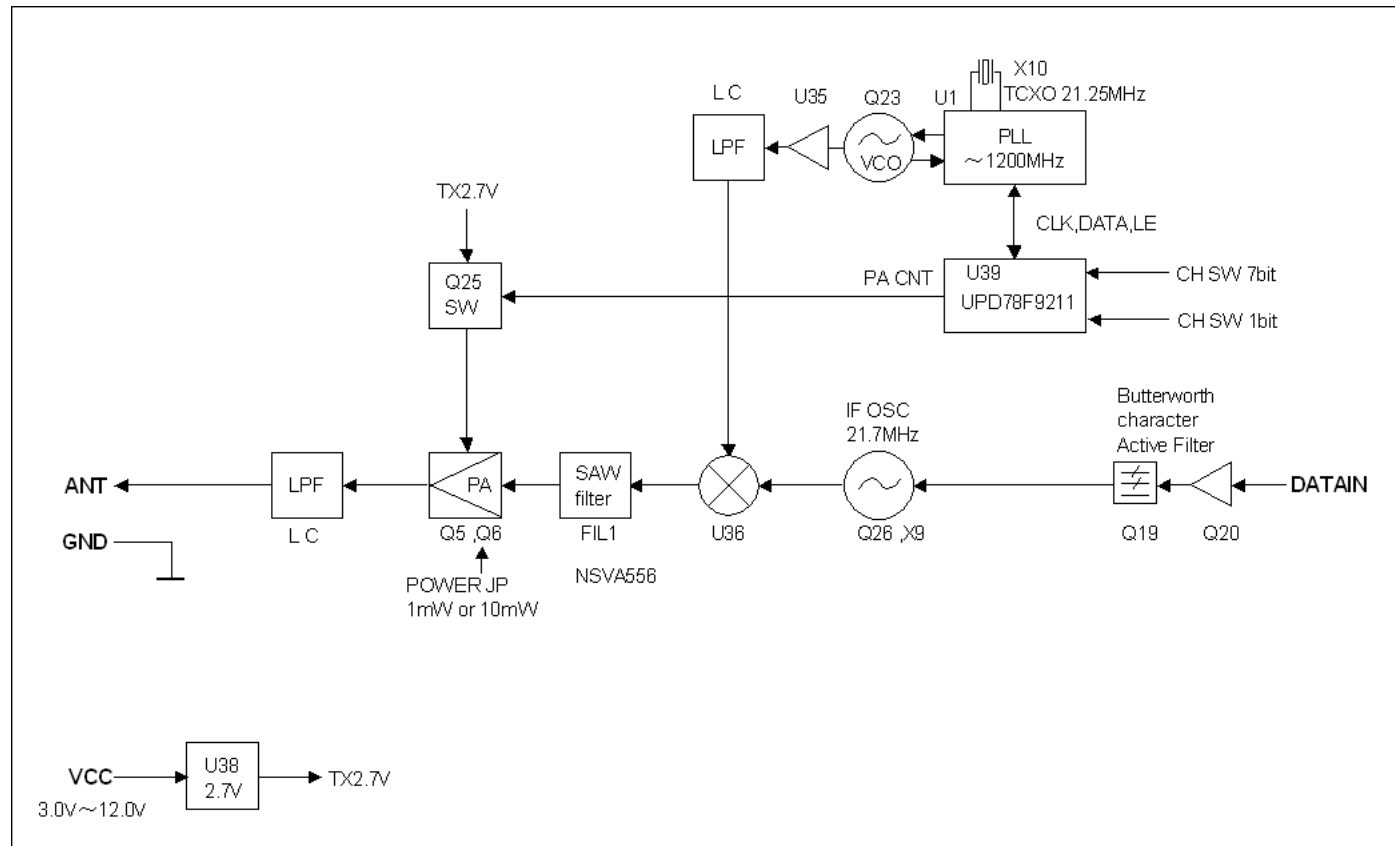

<CDP-RX-02F-R>

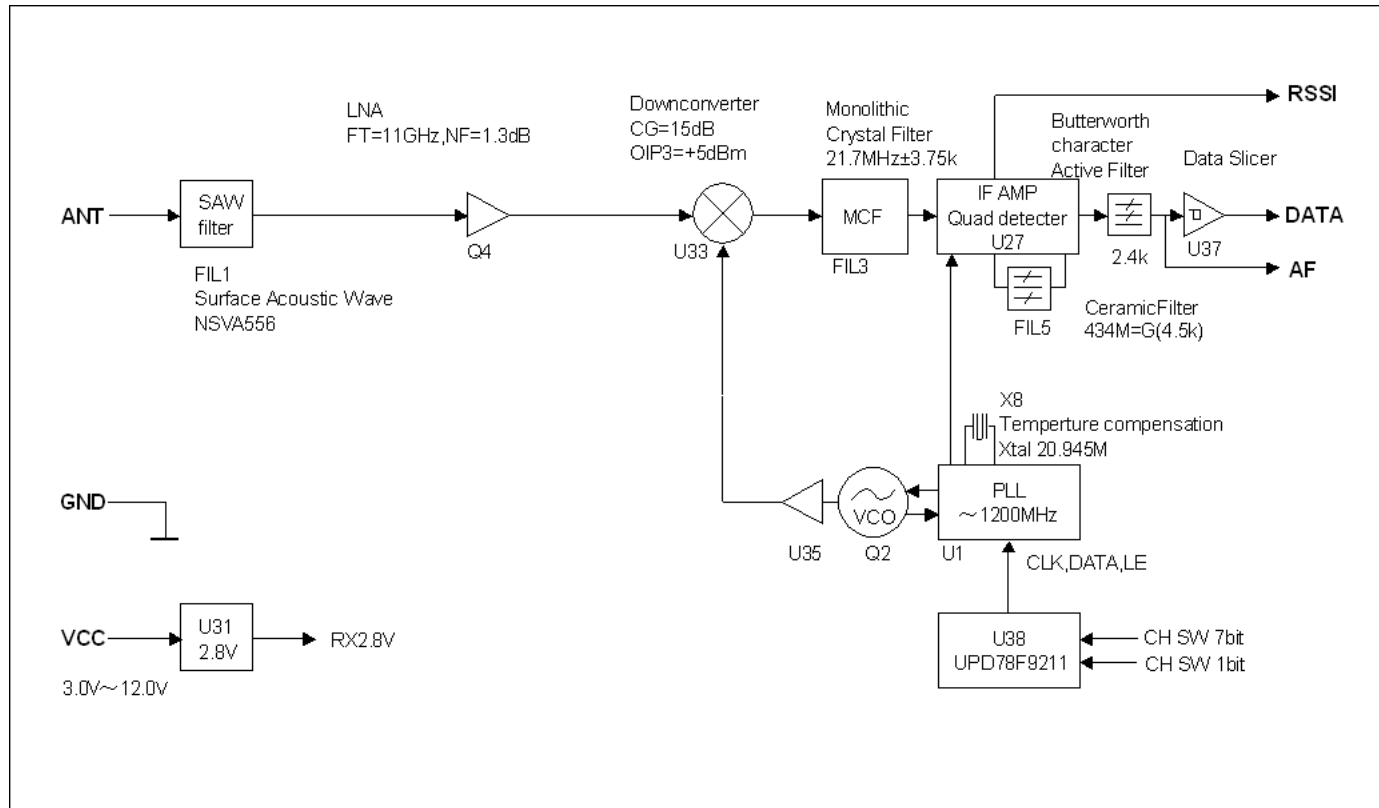

**DIMENSIONS**

<CDP-TX-02F-R>

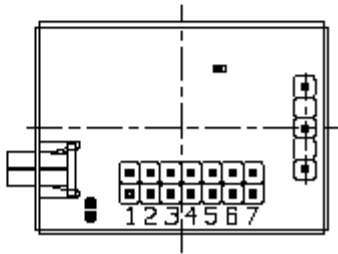
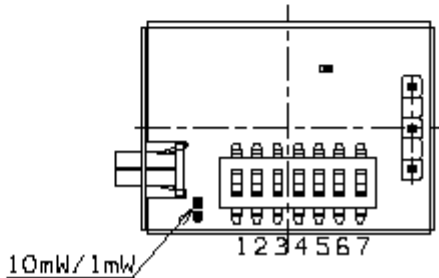
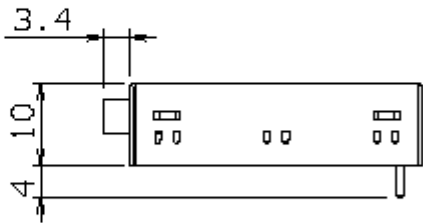
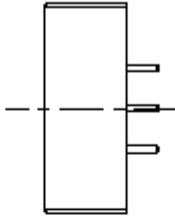
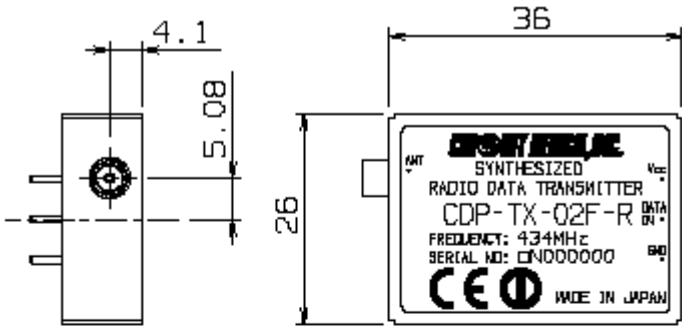

Reference hole position for PCB mounting (Top view)

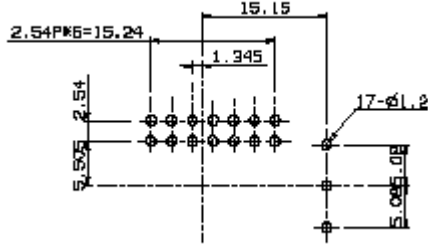

<CDP-RX-02F-R>

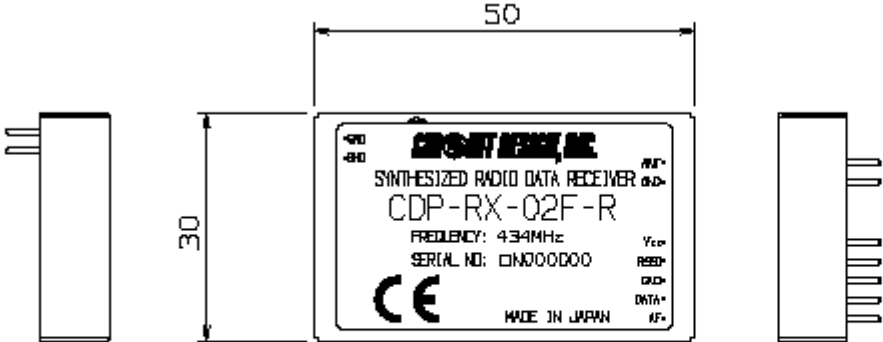

Reference hole position for PCB mounting (Top view)

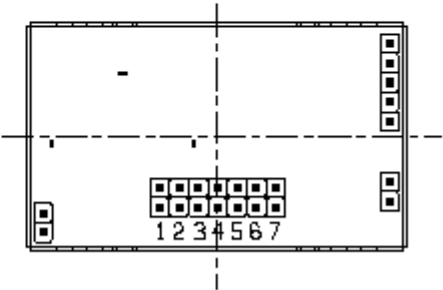
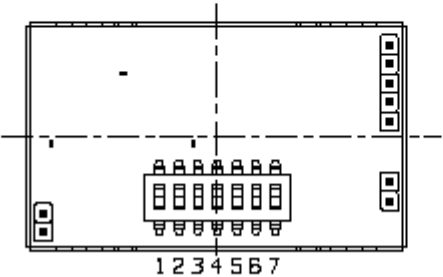
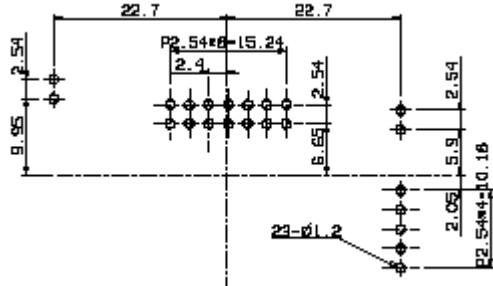



**TEST DATA**

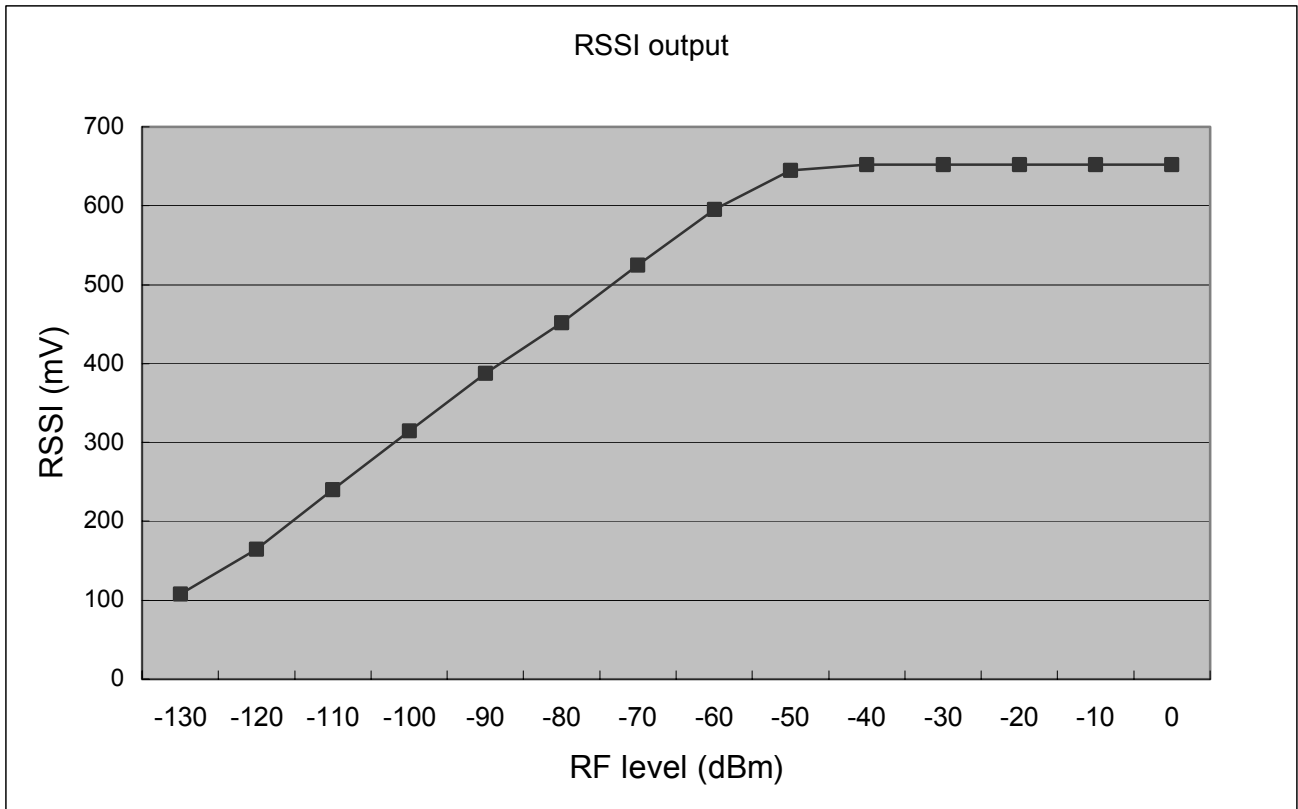

## Regulatory compliance information

### Regulatory compliance of the CDP-TX-02F(P)-R and the CDP-RX-02F(P)-R

the CDP-TX-02F(P)-R and the CDP-RX-02F(P)-R are designed for embedding in other equipment. (Products incorporating the CDP-TX-02F(P)-R and the CDP-RX-02F(P)-R are henceforward referred to as final products.) The European regulation applicable to the CDP-TX-02F(P)-R and the CDP-RX-02F(P)-R is the R&TTE Directive 1999/5/EC. The conformity assessment for the CDP-TX-02F(P)-R and the CDP-RX-02F(P)-R was completed in accordance with the R&TTE Directive Annex II (RX) and III (TX) procedures, and the Declaration of Conformity is attached to this manual.

### Cautions related to regulatory compliance when embedding the CDP-TX-02F(P)-R and the CDP-RX-02F(P)-R

#### 1. Duty cycle

The CDP-TX-02F(P)-R is designed to be used for the Non-Specific Short Range Devices defined in the ERC/REC 70-03 Annex 1.

The CDP-TX-02F(P)-R continuously emits carrier signals when power is supplied. The user must design the final product to meet the requirements of the duty cycle as provided in the *Regulatory parameters related to Annex 1* of the ERC/REC 70-03.

#### 2. Antenna

The CDP-TX-02F(P)-R is supplied with a dedicated antenna and the conformity assessment of the CDP-TX-02F(P)-R was performed using the dedicated antenna (Circuit Design's standard antenna ANT-LEA-01, 1/4 lambda lead antenna). If you use an antenna other than the dedicated antenna or an antenna with equivalent characteristics and performance, further radio conformity assessment may be required.

#### 3. Supply voltage

The CDP-TX-02F(P)-R should be used within the specified voltage range (3.0 V to 12 V).

#### 4. Enclosure

To fulfill the requirements of EMC and safety requirements, the CDP-TX-02F(P)-R and the CDP-RX-02F(P)-R should be mounted on the circuit boards of the final products and must be enclosed in the cases of the final products. No surface of the CDP-TX-02F(P)-R and the CDP-RX-02F(P)-R should be exposed.

### Conformity assessment of the final product

The manufacturer of the final product is responsible for the conformity assessment procedures of the final product in accordance with the R&TTE Directive.

As to the conformity assessment of the R&TTE Directive Article 3.2 (Efficient use of the radio spectrum), the manufacturer of the final product incorporating the R&TTE assessed CDP-TX-02F(P)-R and CDP-RX-02F(P)-R will be exempted from its conformity assessment procedures. For details of how to use the conformity assessment of the CDP-TX-02F(P)-R and the CDP-RX-02F(P)-R, please consult the relevant authorities or accredited certification bodies.

### Notification of the final product

The notification required by R&TTE Directive Article 6 (4) is not necessary if the final product is used in the harmonized frequency band and is classified as Class-1 equipment. If the final product is not used in the harmonized frequency band and is classified as Class-2 equipment, the manufacturer of the final product has a duty to notify the relevant radio regulatory authorities in the countries where the final product is sold.

\*NOTE: In case the CDP-TX-02F(P)-R 434MHz is used with more than a 10% duty, notification of the final product will be required. A list of Class-1 equipment is available at <http://www.ero.dk/>.

### Exemption clause

Circuit Design, Inc does not guarantee the accuracy of the above mentioned information about the conformity assessment and notification of the final product. Directives, technical standards, principles of operation and the like may be interpreted differently by the authorities in each country. Also the national laws and restrictions vary with the country. In case of doubt or uncertainty, we recommend that you check with the authorities or official certification organizations of the relevant countries.

# DECLARATION OF CONFORMITY

## Directive 99/5/EC (R&TTED)

Manufacturer or  
Authorized representative: Circuit Design, Inc.

Address: 7557-1, Hotaka, Azumino-city, Nagano 399-8303  
Japan

We declare on our sole responsibility, that the following product:

**Kind of equipment:** UHF Narrow band multi-channel transmitter & receiver

Type-designation: **CDP-TX-02F-R 434 MHz**  
**CDP-TX-02FP-R 434 MHz**  
**CDP-RX-02F-R 434 MHz**  
**CDP-RX-02FP-R 434 MHz**

is in compliance with the essential requirements of §3 of the R&TTED.

- Health and safety requirements pursuant to §3(1)a:  
Applied Standard(s) or other means of providing conformity:

**EN 60950-1 : 2001**  
**EN 50371 : 2002**

- Protection requirements concerning EMC §3(1)b:  
Applied Standard(s) or other means of providing conformity:

**EN 301 489-1 V1.5.1 (2004-11)**  
**EN 301 489-3 V1.4.1 (2002-08)**

- Measures for the efficient use of the radio frequency spectrum §3(2)  
Applied Standard(s) or other means of providing conformity:

**EN 300 220-3 V.1.1.1 (2000-09)**  
**EN 300 220-2 V.2.1.1 (2006-04)**

Nagano Japan, January 25, 2007  
place and date of issue

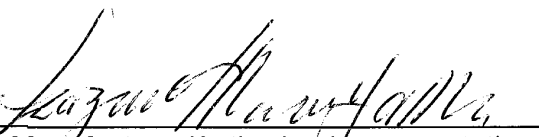
  
Manufacturer/Authorized representative  
name and signature

**Accredited testlaboratory:** mikes-testingpartners gmbh, Ohmstrasse 2-4  
94342 Strasskirchen, Germany

## Cautions

- As the radio module communicates using electronic radio waves, there are cases where transmission will be temporarily cut off due to the surrounding environment and method of usage. The manufacturer is exempt from all responsibility relating to resulting harm to personnel or equipment and other secondary damage.
- Do not use the equipment within the vicinity of devices that may malfunction as a result of electronic radio waves from the radio module.
- The manufacturer is exempt from all responsibility relating to secondary damage resulting from the operation, performance and reliability of equipment connected to the radio module.
- Communication performance will be affected by the surrounding environment, so communication tests should be carried out before actual use.
- Ensure that the power supply for the radio module is within the specified rating. Short circuits and reverse connections may result in overheating and damage and must be avoided at all costs.
- Ensure that the power supply has been switched off before attempting any wiring work.
- The case is connected to the GND terminal of the internal circuit, so do not make contact between the '+' side of the power supply terminal and the case.
- When batteries are used as the power source, avoid short circuits, recharging, dismantling, and pressure. Failure to observe this caution may result in the outbreak of fire, overheating and damage to the equipment. Remove the batteries when the equipment is not to be used for a long period of time. Failure to observe this caution may result in battery leaks and damage to the equipment.
- Do not use this equipment in vehicles with the windows closed, in locations where it is subject to direct sunlight, or in locations with extremely high humidity.
- The radio module is neither waterproof nor splash proof. Ensure that it is not splashed with soot or water. Do not use the equipment if water or other foreign matter has entered the case.
- Do not drop the radio module or otherwise subject it to strong shocks.
- Do not subject the equipment to condensation (including moving it from cold locations to locations with a significant increase in temperature.)
- Do not use the equipment in locations where it is likely to be affected by acid, alkalis, organic agents or corrosive gas.
- Do not bend or break the antenna. Metallic objects placed in the vicinity of the antenna will have a great effect on communication performance. As far as possible, ensure that the equipment is placed well away from metallic objects.
- The GND for the radio module will also affect communication performance. If possible, ensure that the case GND and the circuit GND are connected to a large GND pattern.

## Warnings

- Do not take a part or modify the equipment.
- Do not remove the product label (the label attached to the upper surface of the module.) Using a module from which the label has been removed is prohibited.

### **Circuit Design, Inc. All right reserved**

No part of this document may be copied or distributed in part or in whole without the prior written consent of Circuit Design, Inc.

Customers are advised to consult with Circuit Design sales representatives before ordering.

Circuit Design, Inc. believes the furnished information is accurate and reliable. However, Circuit Design, Inc. reserves the right to make changes to this product without notice.

**REVISION HISTORY**

Version	Date	Description	Remark
1.0	Jan. 2007	CDP-TX/RX-02F-R 434MHz The first issue	
1.1	Feb. 2007	Update DOC	Page 19

## Application note (Design guide for RF transmitter and receiver)

The following problems generally apply to radio modules

Problem	Solution
Touching or moving the antenna changes its impedance, which causes variations in emission power. The variation appears as distortion in the modulating signal and causes communication errors.	Fix the position of the antenna to avoid moving it. Positioning of the antenna is an important factor in operating the radio module efficiently.
If a change in the circuit length occurs due to the on/off of switch etc. in the electronic circuit connected to the radio module in the system in which the radio module is integrated, the high frequency electric potential can vary, disturbing the modulating signal, leading to communication errors.	Add bypass capacitors of 100 to 470 pF in the immediate vicinity of the switches. Make the area beneath the radio module a ground pattern, utilizing part of the shield.
If the power line and/or the signal input line are long the printed line can be subject to high frequency noise. This noise may cause communication errors.	Block high frequency elements by adding a choke coil to each line.
Circuit Design's receivers are designed to be vibration resistant. However there is a limit to the amount of shock and vibration the module can sustain due to its construction.	In order to fix the receiver to the PCB strongly, solder the case to the PCB. When using a radio receiver where vibration is always present, use a shock absorber or fix the PCB at the vicinity of the four corners of the receiver module in addition to fixing the four corners of the PCB on which the radio module is mounted.
Circuit Design's receivers are designed for high sensitivity. They will obtain radio signals over long distances. On the other hand, the receiver is sensitive to noise from the microcomputer and surrounding digital circuits due to its high sensitivity.	Make the area beneath the radio module a ground pattern, utilizing part of the shield. Block high frequency elements by adding a choke coil to each line.

For stable operation, it is recommended to solder the shield case to PCB wide plane GND



● Soldering point

A PCB example built for CDP-TX-02E taking into consideration the above points is shown below.

**Model No. RPB-T02N-1**

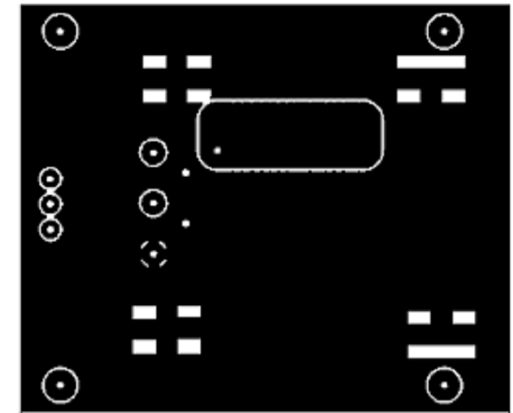
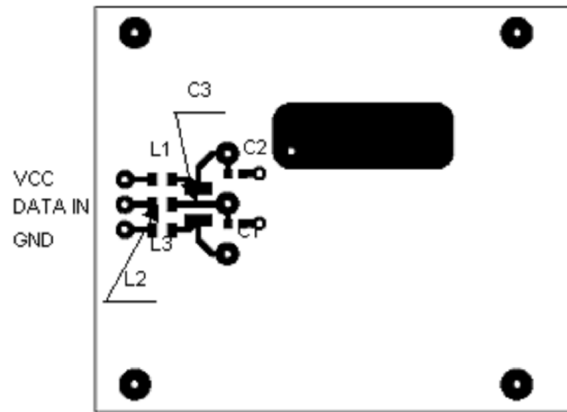
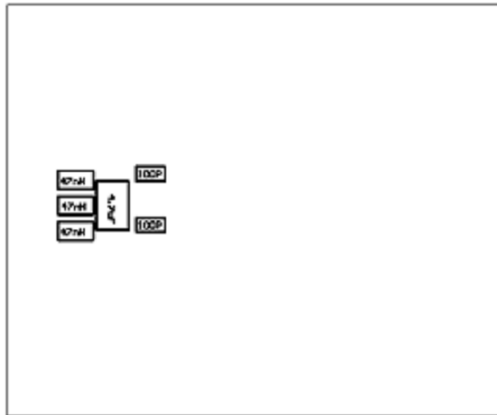
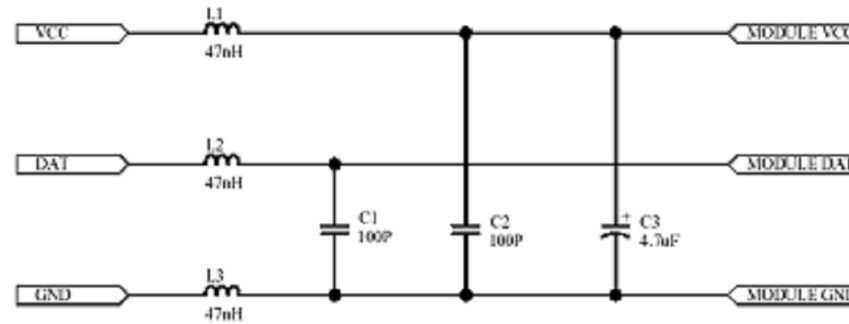
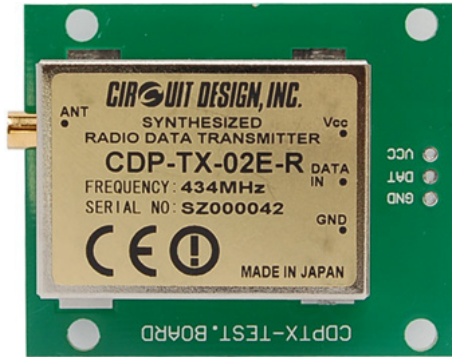

Circuit Design, Inc. All rights reserved.

No part of this document may be copied or distributed in part or in whole without the prior written consent of Circuit Design, Inc.